

Bticino Conectado Connected WD

Relator: Oscar Godoy
Product Manager



Aportando valor a tu profesión

legrand bticino
academy
PROGRAMAS DE CAPACITACIÓN

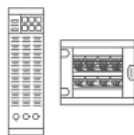

Introducción

Relator: Oscar Godoy
Product Manager



Aportando valor a tu profesión

legrand bticino
academy
PROGRAMAS DE CAPACITACIÓN



Introducción



**BTICINO
CONECTADO**



Control inteligente a distancia de los sistemas eléctricos y seguridad instalados en una instalación



Introducción



Home+Control

Una única APP para la gestión de iluminación, enchufes, termorregulación y consumo energético.



Home+Security

Para la gestión de la Videocitofonía y productos Netatmo-Security

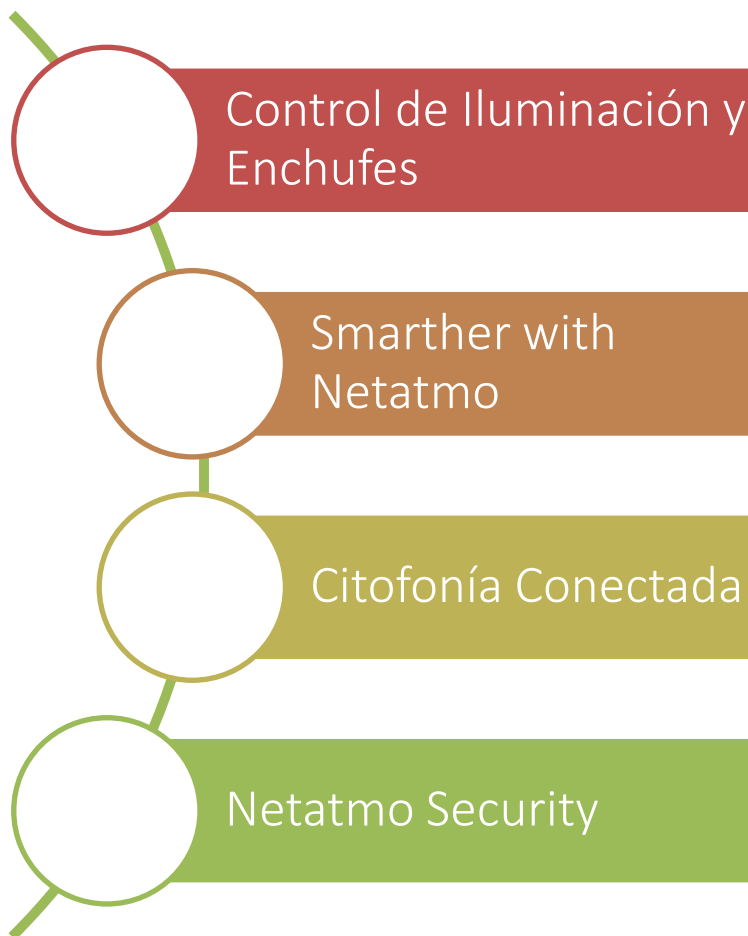

Classe 300OES
Classe 100x
EASYKIT



Introducción



Living Now WITH NETATMO



Livinglight WITH Netatmo

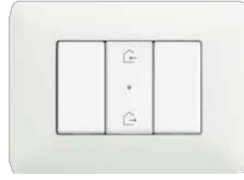

Màtix WITH Netatmo

SERIES ELECTRICAS SMART PARA CONTROLAR PERSIANAS, ILUMINACIÓN & ENCHUFES FACILMENTE DESDE TU VOZ, SMARTPHONE, O PLACA



ADAPTA LA **TEMPERATURA** DE ACUERDO A TU **RUTINA DIARIA**



OBTEN ALERTAS EN CUALQUIER PARTE EN CASO DE **ALARMAS**

MANTÉN UN OJO EN TU CASA Y SIENTETE TRANQUILO



CONTROLA TU YOUR **ILUMINACIÓN & CARGAS** FACILMENTE DESDE TU VOZ, SMARTPHONE, O PLACA



SALUDA A TUS VISITAS INCLUSO CUANDO ESTÉS LEJOS DE CASA

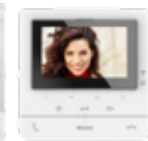

Introducción

BTICINO CONECTADO

Transforma tu instalación tradicional en una **Smart**



HOME-CONTROL
Una única APP para la gestión de iluminación, enchufes, termostatación y consumo energético.

HOME-SECURITY
Para la gestión de la videofonía y productos Netatmo.

bticino



Con una casa Inteligente, todo es mas fácil....

Con un solo clic para apagar toda la casa, o colocar un mando donde se quiera, sin cables.



¡La vivienda es mas segura!!!.

Evita apagones o recibe notificaciones en caso de mal funcionamiento, o revisar cámara inteligentes o videoportero.



¡Máximo Confort!!!.

Puedes crear escenarios para gestionar múltiples dispositivos, subir la temperatura antes de llegar a casa, abrir la puerta desde el Smartphone o dar instrucciones por voz....



¡¡Más control, más ahorro!!

Ten el control del consumo de electricidad y calefacción de la vivienda, de forma diaria, semanal o anual.





Introducción

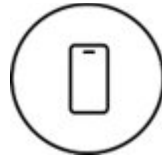

TODO YA ES SMART
Todos tenemos un Smartphone



NO CAMBIA EL TRABAJO
La instalación es igual que siempre



ESPECIALIZACIÓN
Socios actualizados con la tecnología

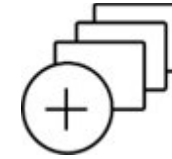

PERSONALIZACIÓN
Se puede avanzar de a poco con el proyecto



MAYOR PLUSVALIA
Aumento del valor de la vivienda



AHORRO DE ENERGÍA
Gestión del consumo y programas automáticos



INTEGRACIÓN
Compatibilidad nativa con Apple, Google, Alexa y otros.

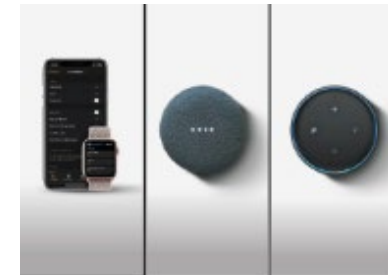

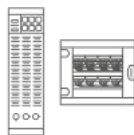

Tecnología

Relator: Oscar Godoy
Product Manager



Aportando valor a tu profesión

legrand bticino
academy
PROGRAMAS DE CAPACITACIÓN

Comparación Técnica



BTICINO
CONECTADO

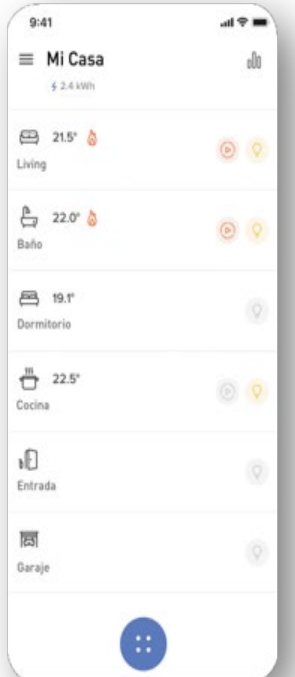
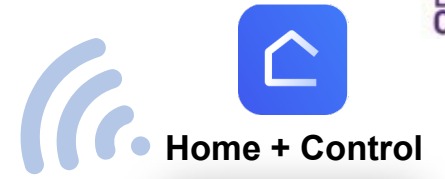

- CONTROL A DISTANCIA
- CREACIÓN DE ESCENARIOS
- CONTROL POR VOZ
- PROGRAMACIÓN HORARIA

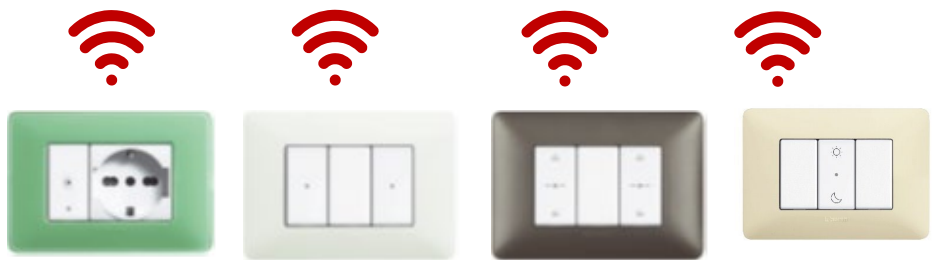



Comparación Técnica



El grupo Legrand es miembro fundador del proyecto “Connected homes over IP”, que permite la integración de productos inteligentes de distintas marcas de manera nativa.



Comparación Técnica



Los requisitos de la Norma **ISO 27001** nos aportan un **Sistema de Gestión de la Seguridad de la Información (SGSI)**, consistente en medidas orientadas a **proteger la información**, indistintamente del formato de la misma, contra cualquier amenaza, de forma que garanticemos en todo momento la continuidad de las actividades de la instalación.

Los Objetivos del SGSI son preservar la:
Confidencialidad
Integridad
y **Disponibilidad** de la Información



Introducción



La ISO 27001, asegura la confidencialidad de los datos de los usuarios y la no comercialización de éstos.



Comparación Técnica



Bureau Veritas Certification

NETATMO
93, RUE NATIONALE
92100 BOULOGNE BILLANCOURT
FRANCE

This is a multi-site certificate, additional site(s) are listed on the next page(s)

Bureau Veritas Certification Holding SAS – UK Branch certifies that the Management System of the above organisation has been audited and found to be in accordance with the requirements of the management system standards detailed below

ISO/IEC 27001:2013

Scope of certification

DELIVERY AND MAINTENANCE OF PRODUCTS AND SERVICES TO OUR "WITH NETATMO" PARTNERS AND ELIOT CLOUD SERVICE TO LEGRAND BUS, AND THEIR END USERS.

Statement of Applicability Version number and release date:
SMSL_DDA_Applicability ISO27001_Process_Mapping_20191102_02/11/2019

Original cycle start date: 17 February 2020
Expiry date of previous cycle: N/A
Certification / Recertification Audit date: 17 January 2020
Certification / Recertification cycle start date: 17 February 2020

Subject to the continued satisfactory operation of the organization's Management System, this certificate expires on: 16 February 2023

Certificate No. FR057581 Version: 1 Revision date: 17 February 2020
Contract No. 7282573

Laurent CROGUENNEC - Managing Director,
Signed on behalf of BVCH SAS UK Branch

Certification body address: 66 Prescott Street, London E1 8HG, United Kingdom
Local office: Bureau Veritas Certification France - 60 avenue du Général de Gaulle
92046 Paris la Defense

Further clarifications regarding the scope of this certificate and the applicability of the management system requirements may be obtained by consulting the organisation.
To check this certificate validity please call: +33(0) 1 41 87 00 60.

Disponible en sección certificados de www.bticino.cl



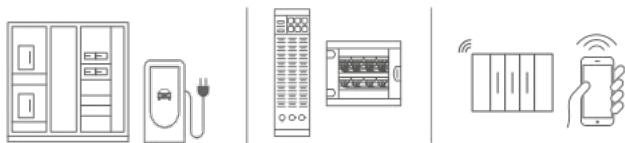

Presentación Oferta Connected WD

Relator: Oscar Godoy
Product Manager



Aportando valor a tu profesión

legrand bticino
academy
PROGRAMAS DE CAPACITACIÓN



Living Now with NETATMO

Sistema eléctrico Smart

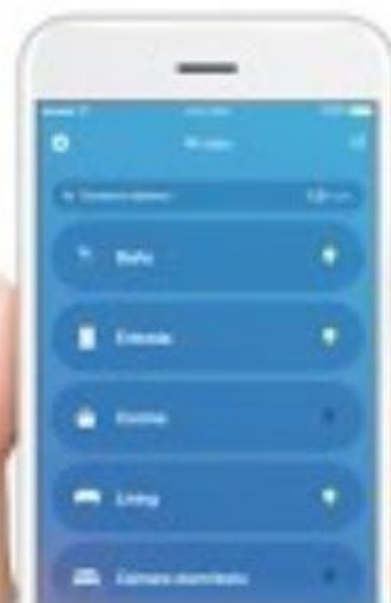

Guía rápida de selección

Living Now ^{WITH} Netatmo Sistema Electrónico Smart

BTICINO CONECTADO

Living Now ^{WITH} Netatmo

Guía de selección rápida

El icano de siempre, ahora Smart. Una nueva generación con un diseño único, sumado a la simplicidad de tecnología Smart. Compatible con los asistentes de voz, Google, Siri o Alexa. Cree sistemas inteligentes sin cambiar sus hábitos de uso.

bticino

CONTROLES INALÁMBRICOS A BATERÍA

CONTROL A BATERÍA | CONTROL DE TEMPERATURA | CONTROL DE VENTILADOR | CONTROL DE ILUMINACIÓN | CONTROL DE ESCENARIOS | CONTROL DE MOVIMIENTO

CONEXIÓN REMOTA	ESCENARIOS
<p>DISPOSITIVO CONECTADO (230V A.C.)</p> <p>Art. K4500C Gateway con mando de escenarios Entrar-Salir</p> <p>Art. K4510C Gateway con mando de escenarios Entrar-Salir</p> <p>Art. FC800T Gateway a riel DIN</p>	<p>CONTROLES INALÁMBRICOS A BATERÍA</p> <p>Art. K4570CW Mando de escenarios Entrar-Salir</p> <p>Art. K4570CW1 Mando de escenarios Entrar-Salir</p> <p>Art. K4575CW Mando de 4 escenarios</p> <p>Art. K4574CW Mando de escenarios Dia-Noche</p> <p>Art. K4574CW1 Mando de escenarios Dia-Noche</p>

App HOME + CONTROL

Disponible en App Store | Disponible en Google Play

Una gama simple y funcional de dispositivos conectados, tanto cableados como inalámbricos.

ILUMINACIÓN	PERSIANAS	ENERGÍA
<p>Art. FC80RC Telerruptor conectado - 16 A</p> <p>Art. 3584C Micromódulo 1,3 A</p> <p>Art. K4003C Interruptor 9/12-9/24 conectado (conexión neutro)</p> <p>Art. K4411C2 Interruptor ON/OFF o Dimmer</p> <p>Art. K4003CW Control para iluminación o toma de corriente conectada</p> <p>Art. K4003CW1 Control modular inalámbrico para iluminación o toma de corriente conectada</p>	<p>Art. K4027C Interruptor de persianas conectado</p> <p>Art. K4027CW1 Control modular inalámbrico para persianas</p> <p>Art. K4027C Control modular inalámbrico para persianas</p> <p>Art. 3585C Sensor de movimiento conectado</p>	<p>Art. K4531C Módulo enchufe conectado - 16A</p> <p>Art. FC80CC Contactor conectado 20A - Riel DIN</p> <p>Art. F20T60A Medidor de energía conectado - Riel DIN</p> <p>Art. FC800CS Módulo gestión de carga conectado - Riel DIN</p> <p>Art. XW8002 (Instalación embutida - Color Blanco)</p> <p>Art. XW8002W (Instalación Sobrepuesta - Color Blanco)</p> <p>Art. XM8002 (Instalación embutida - Color Arena)</p> <p>Art. XG8002 (Instalación embutida - Color Negro)</p>



Guía rápida de selección

Livinglight ^{WITH} Netatmo

Sistema Smart

Una sencilla y práctica selección de productos, cableados e inalámbricos conectados.



BTICINO CONECTADO

Livinglight ^{WITH} Netatmo

Guía de selección rápida

La serie más diversa de Bticino, ahora es Smart. Control desde la App Home-Control. Compatible con los asistentes de voz Google, Siri o Alexa.

Cree sistemas inteligentes sin cambiar sus hábitos de uso.

BTICINO

CONEXIÓN REMOTA	ESCENARIOS	ILUMINACIÓN	PERSIANAS	GESTIÓN DE LA ENERGÍA Y CONSUMO
<p>DISPOSITIVOS CONECTADOS (230V A.C.)</p> <p>Artículo L/N/NT4500C Gateway con control de escenarios Entrada&Salida</p> <p>Artículo L/N/NT4510C Gateway con control de escenarios Entrada&Salida</p> <p>Artículo FC80GT Gateway DIN</p>	<p>PRODUCTOS INALÁMBRICOS</p> <p>Artículo L/N/NT4570CW Comando inalámbrico de escenarios Entrar&Salir</p> <p>Artículo LN4570CWI Comando inalámbrico de escenarios Entrar/Salir</p> <p>Artículo L/N/NT4575CW Comando inalámbrico de 4 escenarios</p> <p>Artículo L/N/NT4003CW Comando inalámbrico</p> <p>Artículo L/N/NT4003CW Comando inalámbrico doble</p> <p>Artículo LN4574CW Comando inalámbrico de escenarios Día/Noche</p> <p>Artículo LN4574CWI Comando inalámbrico de escenarios Día/Noche</p>	<p>ILUMINACIÓN</p> <p>Artículo FC80RC TelerruptorDIN conectado 16 A</p> <p>Artículo 3584C Relé de luz conectado 1,3 A</p> <p>Artículo L/N/NT4003C Interrupor de dos vías conectado</p> <p>Artículo L/N/NT4411C Interrupor/ regulador conectado</p>	<p>PERSIANAS</p> <p>Artículo L/N/NT4027C Comando inalámbrico conectado</p> <p>Artículo 4027C Micromódulo conectado</p>	<p>GESTIÓN DE LA ENERGÍA Y CONSUMO</p> <p>Artículo L/N/NT4531C Módulo para enchufe conectado -16 A</p> <p>Artículo FC80CC Contactor DIN conectado 20 A</p> <p>Artículo F20T60A Módulo DIN conectado de medidas de consumo</p> <p>Artículo FC80CCS Módulo DIN conectado de gestión de cargas</p> <p>Termostato conectado Artículo XW8002 Artículo XW8002W Artículo XM8002 Artículo XG8002</p>

Nota: Los productos también están disponibles en acabados en blanco, gris y tech.
Consulta el catálogo para obtener descripciones detalladas, disponibilidad y gama completa de productos.



Guía rápida de selección

Guía de selección rápida

bticino

Instalación eléctrica Smart

Una gama completa de dispositivos conectados, cableados e inalámbricos.



BTICINO CONECTADO

Màtix with Netatmo

Guía de selección rápida

Disegno italiano, allora Smart
Toda la funzionalità qui racchiusa,
sumata a la semplicità de tecnologia Smart.
Compatibile con los asistentes de voz, Google, Siri e Alexa.

Cree sistemas inteligentes sin cambiar sus hábitos de uso.

BTICINO

CONEXIÓN REMOTA	ESCENARIOS	ILUMINACIÓN	PERSIANAS	GESTIÓN DE ENERGÍA Y CONSUMO
<p>Gateway</p> <p>CONEXIÓN (230V A.C.)</p> <p>Art. AM4510C Gateway con comando ENTRAR/SALIR</p> <p>Art. FC80GT Gateway DIN</p>	<p>Mando de escenario</p>	<p>Comando luces</p> <p>Art. FC80RC Telerruptor DIN conectado 16 A</p> <p>Art. 3584C Micromódulo conectado 1,3 A</p> <p>Art. AM4003C Interruptor On/Off conectado</p> <p>Art. AM4411C Dimmer conectado</p> <p>Art. AM4003CW1 Mando inalámbrico alumbrado</p> <p>Art. 3585C Sensor de movimiento</p>	<p>Comando persianas</p> <p>Art. AM4027C Comando persianas conectado</p> <p>Art. AM4027CW1 Mando inalámbrico persianas</p>	<p>Enchufe conectado</p> <p>Art. AM4531C Módulo enchufe conectado -16 A</p> <p>Art. FC80CC Contactor DIN conectado 20 A</p> <p>Art. F20T60A Medidor DIN conectado</p> <p>Art. FC80GCS Módulo gestión de carga DIN conectado</p> <p>Termostato conectado</p> <p>Art. XW800Z Art. XW800ZW Art. XM800Z Art. XG800Z</p>
<p>MANDOS INALÁMBRICOS</p>	<p>Art. AM4570CW1 Mando Entrar/Salir</p> <p>Art. 3528C* Mando de 4 escenarios adicionales *Disponible desde Noviembre de 2022</p> <p>Art. AM4574CW1 Mando Día/Noche</p>			



Bticino Conectado - Micromódulo

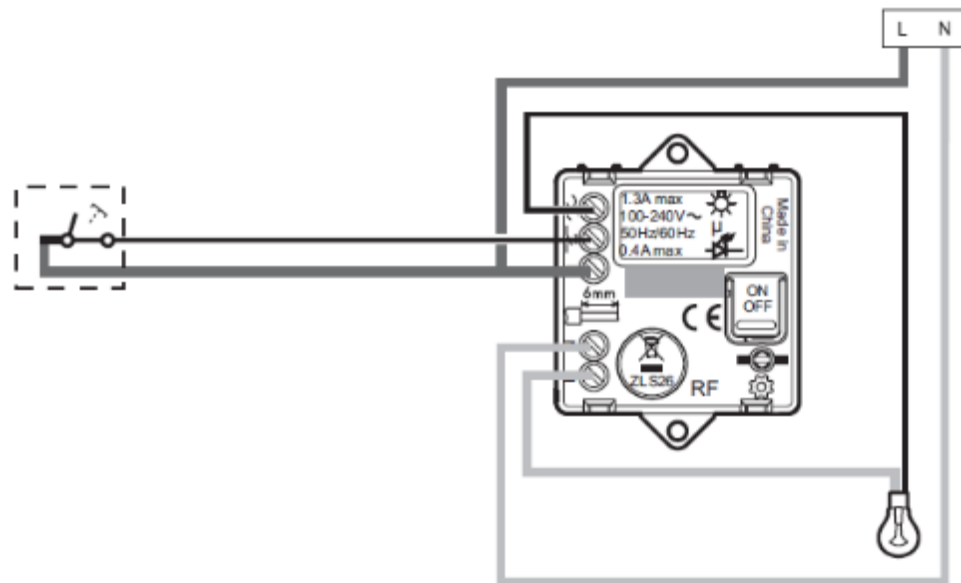

Micromódulo



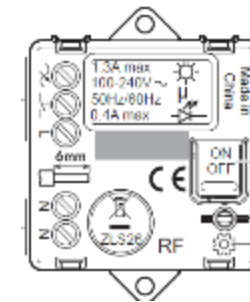

Living Now WITH Netatmo

Livinglight WITH Netatmo



Art. 3584C



+ 45 °C + 5 °C 1 x 1,5mm ² 1 x 1,5mm ² 1 x 1,5mm ² 2مم 1,5 x 1 100 - 240 Vac ; 50/60 Hz 100 - 240 B ; 50/60 Γ ₄ فولت 240 - 100; هرتز 60 - 50		LED 					
	Lâmpada incandescente ou lâmpada de halogênio	Lâmpada de LED	Fluorescente compacta	Transformador eletrônico	Transformador ferromagnético		
Cargas	240 VAC	Max.	300 W	(*) 100 W	250 VA	250 VA	250 VA



Bticino Conectado – Interfa contacto

Interfaz aparatos electricos

Living Now WITH Netatmo Livinglight WITH Netatmo



!!Funciona sin tensión!!!

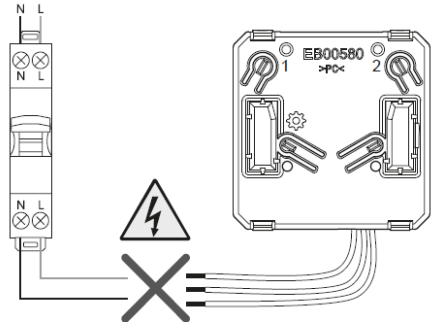

Conexión

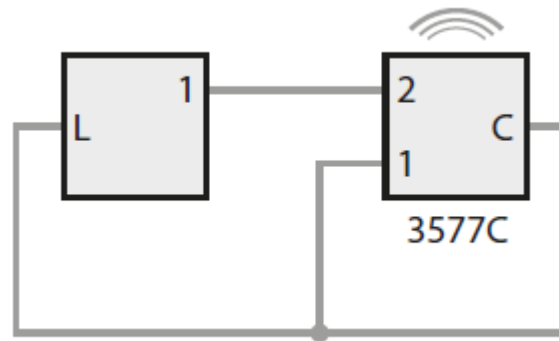
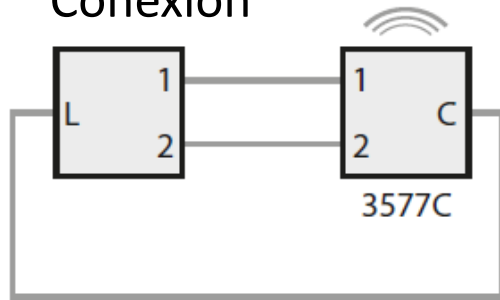

Art. 3577C
Art. 3577C

9/24

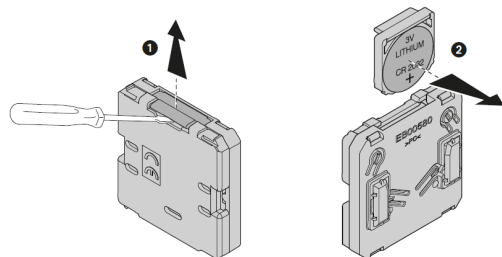

9/12

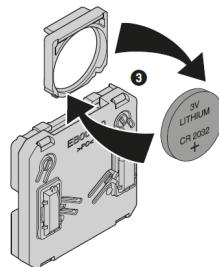

Permite conectar cualquier aparato (9/12-9/24) para que pueda accionar un dispositivo Smart. Configuración y asociación a través de App Home+Control





Bticino Conectado – Sensor movimiento

Sensor PIR

Tipo de sensor	Detector de movimiento PIR con ángulo de detección a 180º y sensor de luminosidad
Cobertura volumétrica	2 - 8 m
Sensor de luminosidad	5 - 1000 LUX
Temporización	15 segundos - 15 minutos
Grado de protección	IP44

Living Now WITH Netatmo

Livinglight WITH Netatmo

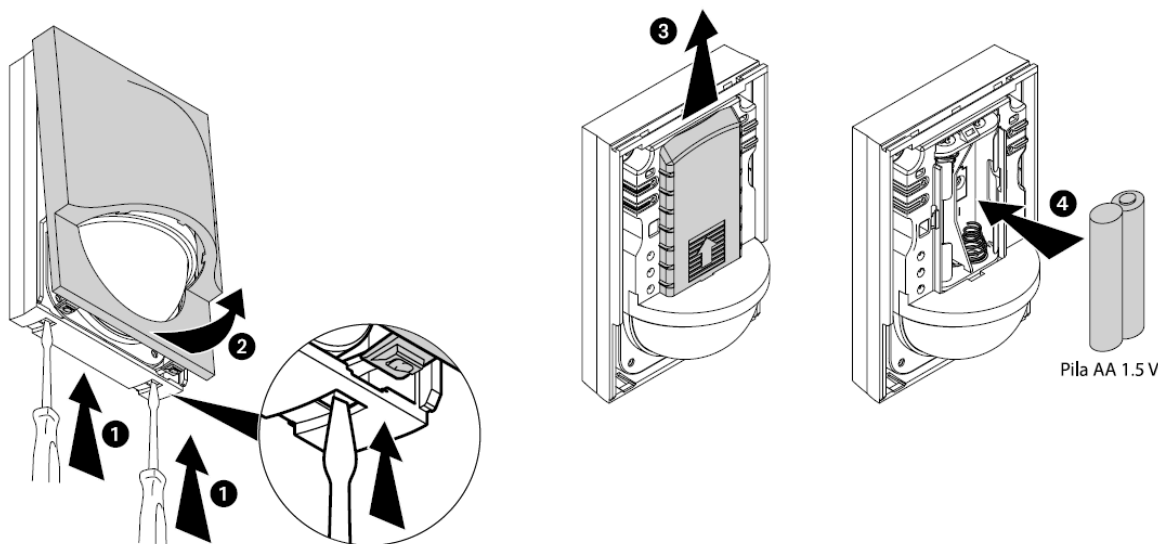

!!Funciona sin tensión!!!



Art. 3585C

Permite controlar dispositivos Smart. Configuración y asociación a través de App Home+Control



Bticino Conectado – Medidor de energía

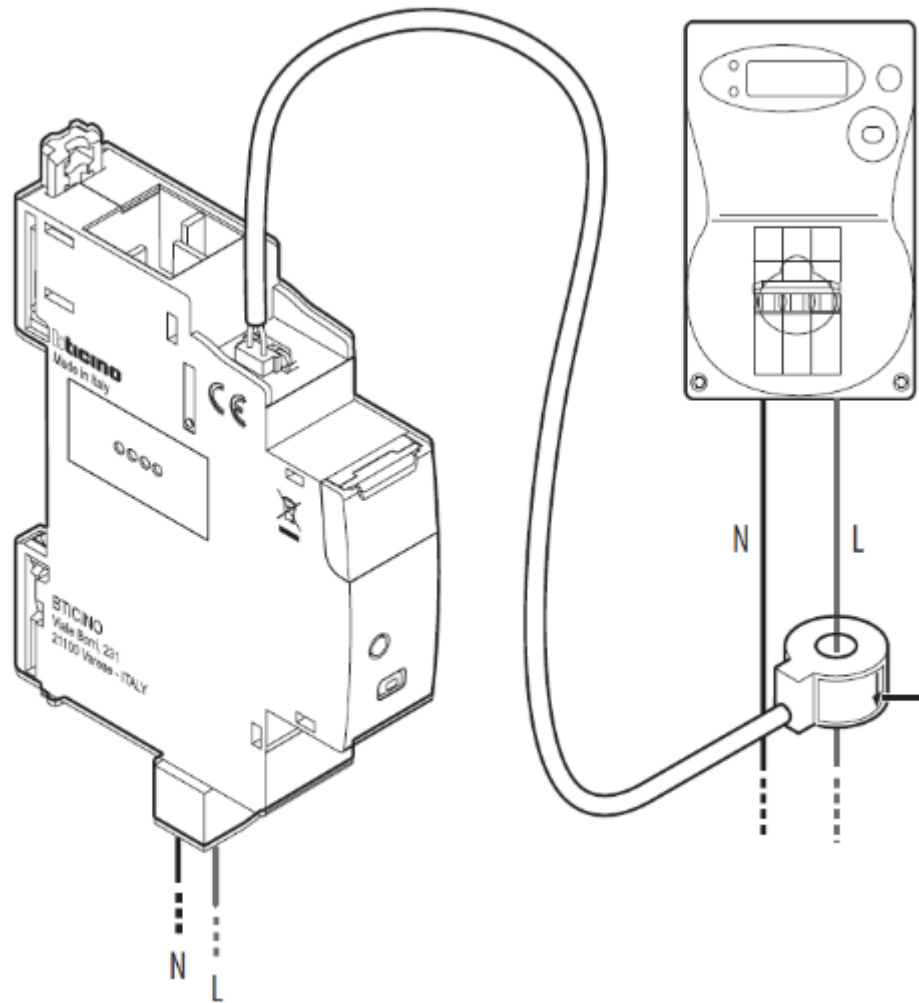

Living Now WITH Netatmo

Livinglight WITH Netatmo



Art. F20T60A

BT DIN WITH Netatmo





Bticino Conectado – Contactor

Contactor conectado

Living Now WITH Netatmo

Livinglight WITH Netatmo



Art. FC80CC

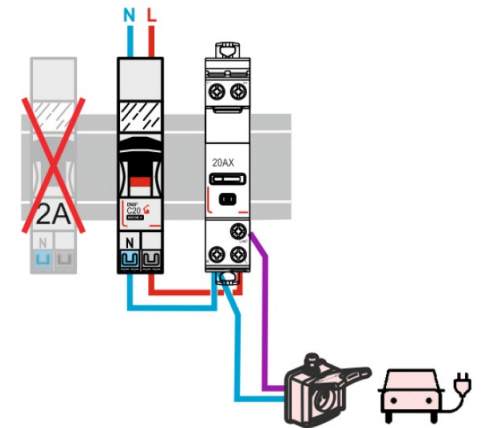
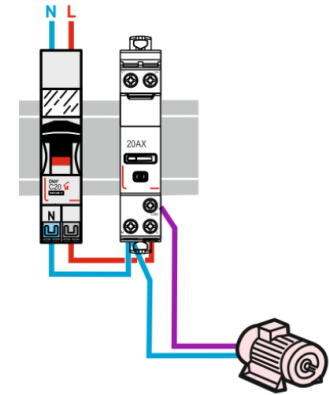
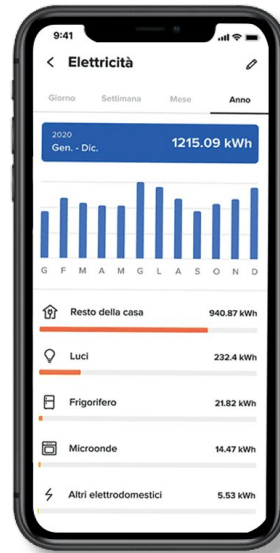

BTDIN WITH Netatmo



Bticino Conectado – Contactor

Telerruptor conectado

Living Now WITH Netatmo Livinglight WITH Netatmo



Art. FC80RC

BTDIN WITH Netatmo

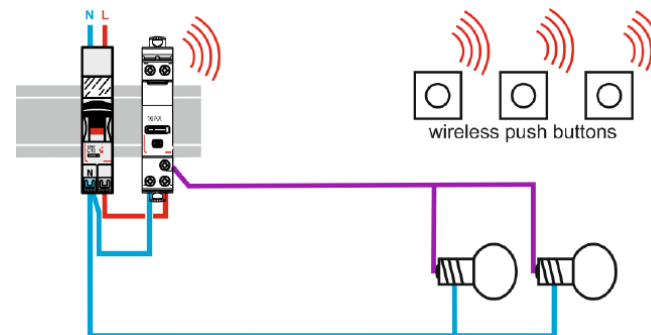
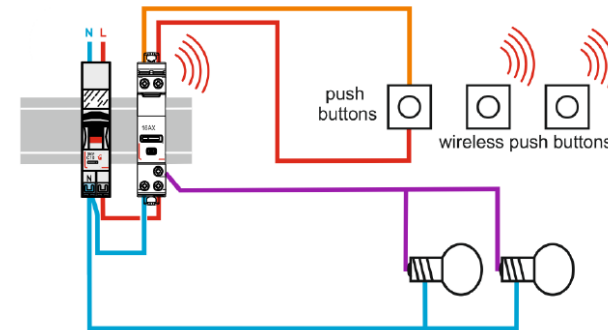
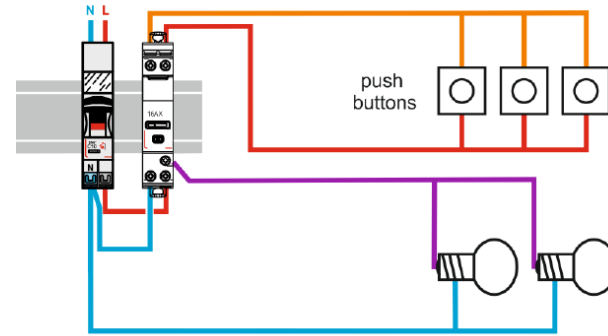



Bticino Conectado – Contactor

Gateway a riel DIN

Living Now WITH Netatmo Livinglight WITH Netatmo



Art. FC80GT

BTDIN WITH Netatmo

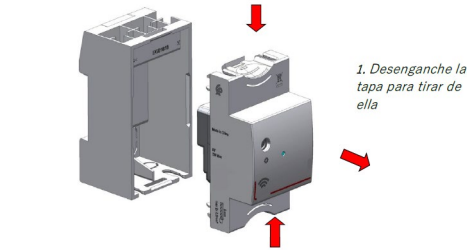

1. Desenganche la tapa para tirar de ella

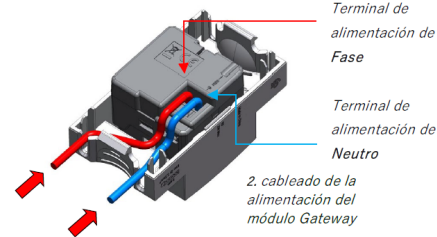

Terminal de alimentación de Fase

Terminal de alimentación de Neutro

2. cableado de la alimentación del módulo Gateway

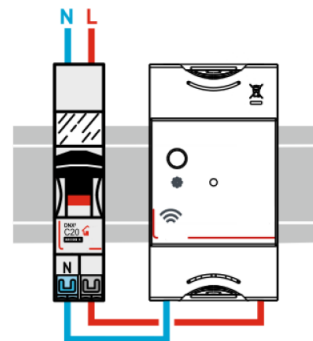

Home + Control



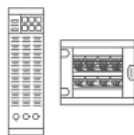

Videos Programación

Relator: Oscar Godoy
Product Manager



Aportando valor a tu profesión

legrand bticino
academy
PROGRAMAS DE CAPACITACIÓN

Bticino Conectado

Instalación eléctrica SMART
Instalación de interruptor conectado

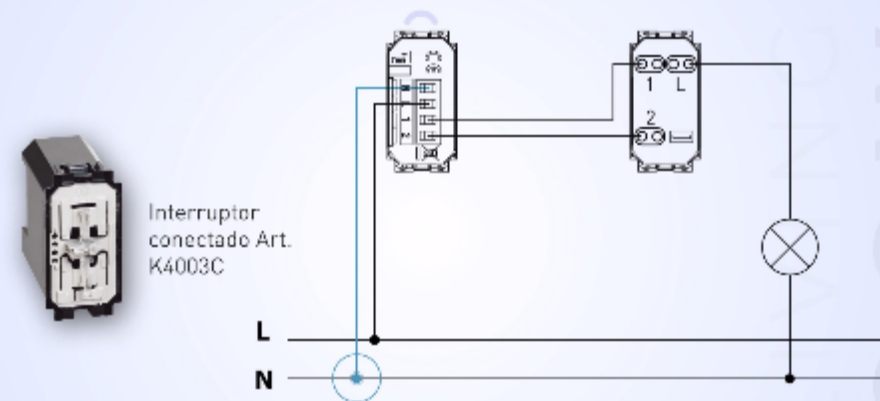

Conectar los cables de Fase y Neutro al dispositivo



Presione y mantenga presionado el centro del mando wireless de escenario. Entrar & Salir modo de configuración con el Gateway

Cuando el led verde comienza a parpadear, deje de presionar el centro del mando

bticino

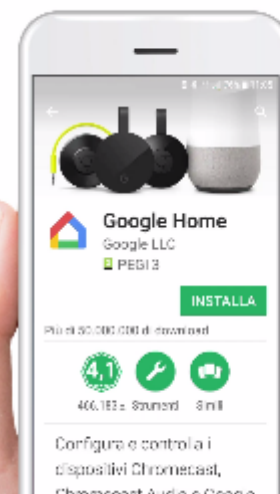

Asocia **Living Now** con el asistente de voz de **Google Home** en pocos pasos:

Google Assistant

bticino



Bticino Conectado

Interruptor On/Off conectado

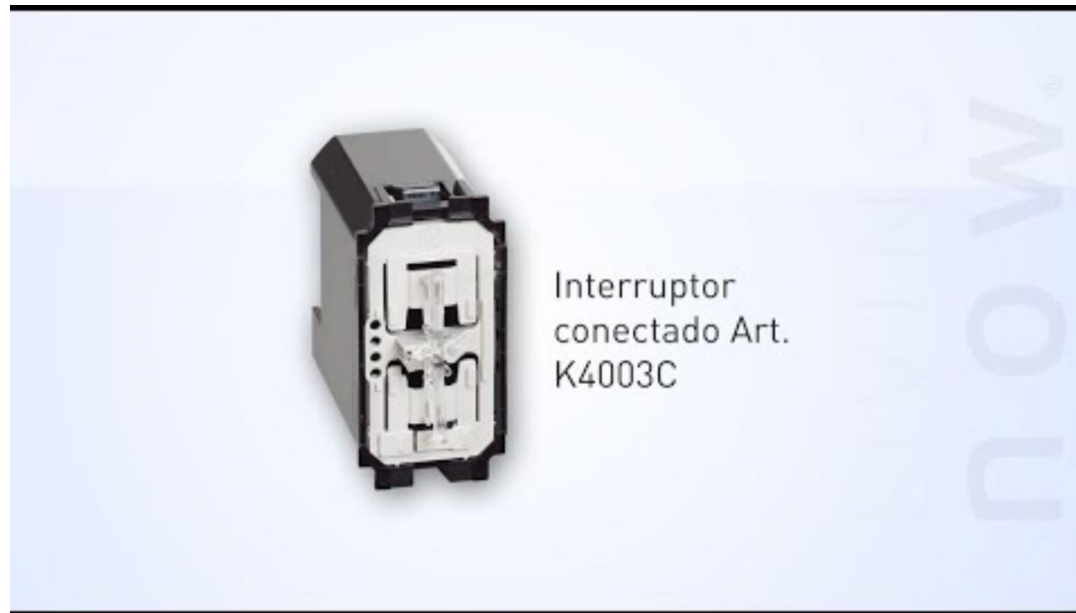

<https://youtu.be/HSWYNTDOblo>

Modulo Enchufe conectado



<https://youtu.be/OP4yN1QLpc4>



Bticino Conectado

Micromódulo conectado



<https://youtu.be/-m8vvMTINhE>

Módulo inalámbrico conectado

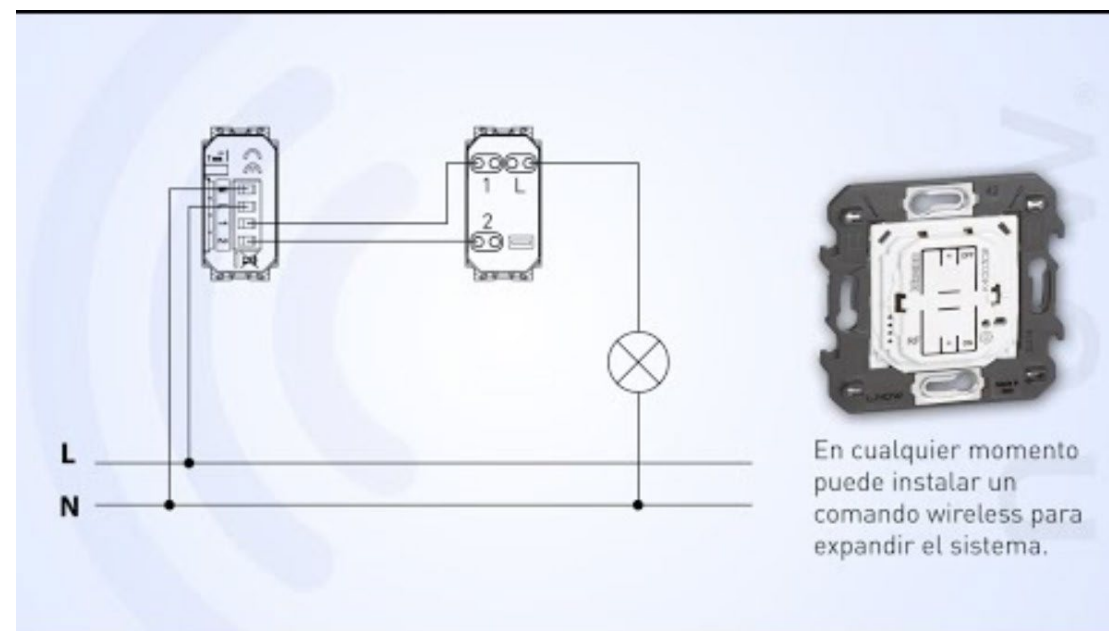

<https://youtu.be/yOzjYJQMXVk>





Bticino Conectado

Medidor de energía conectado



<https://youtu.be/ghBozGkcr7c>

Módulo persianas conectado



<https://youtu.be/JeyRD-d1rCk>



Bticino Conectado

Configuración APP Home+Control

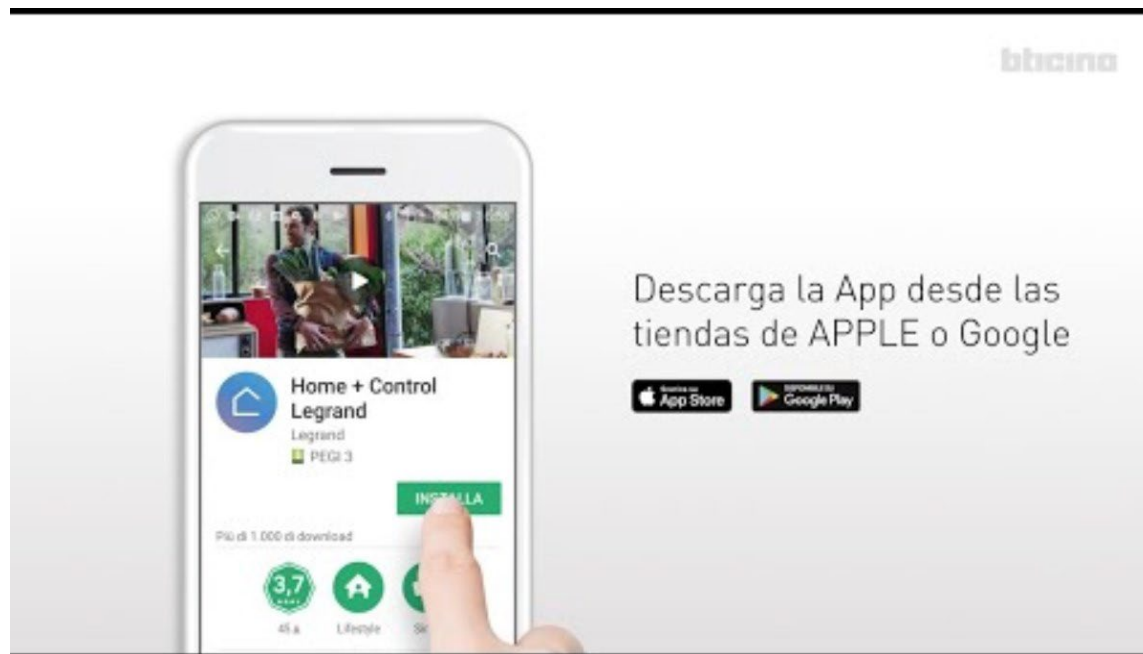

<https://youtu.be/zPjw5SNO6Lo>

Configuración de Asistente de Voz

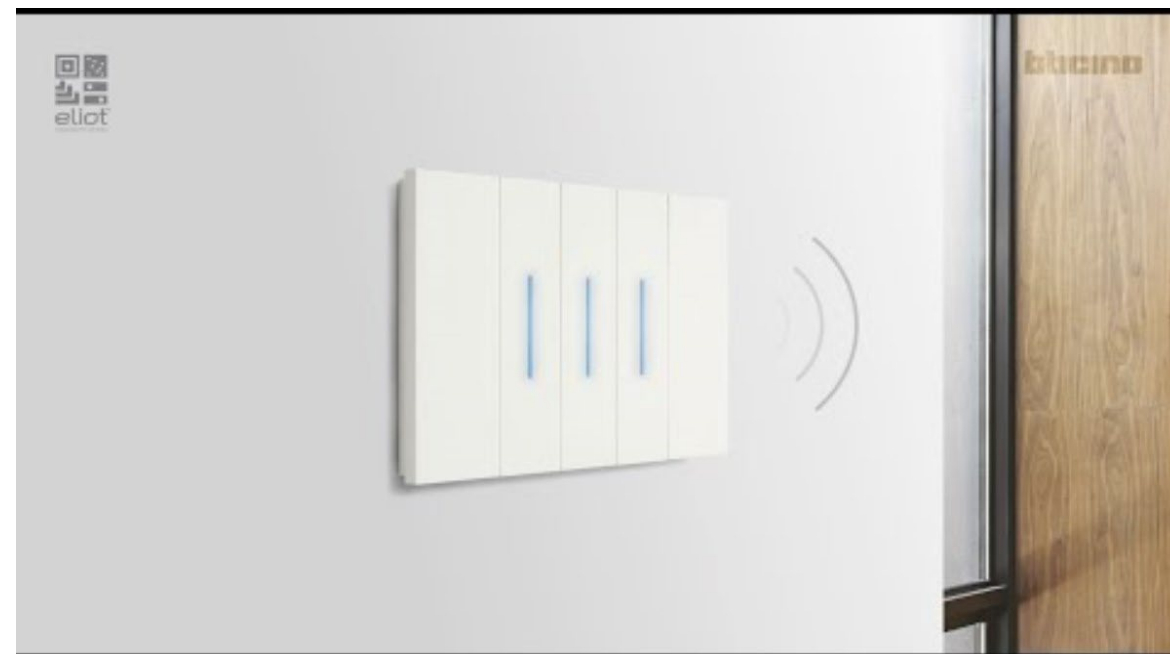

<https://youtu.be/SeL2jYuch0I>





Bticino Conectado



Pulse y suelte las dos teclas del mando inalámbrico
ENTRAR/SALIR al mismo tiempo.



Bticino Conectado

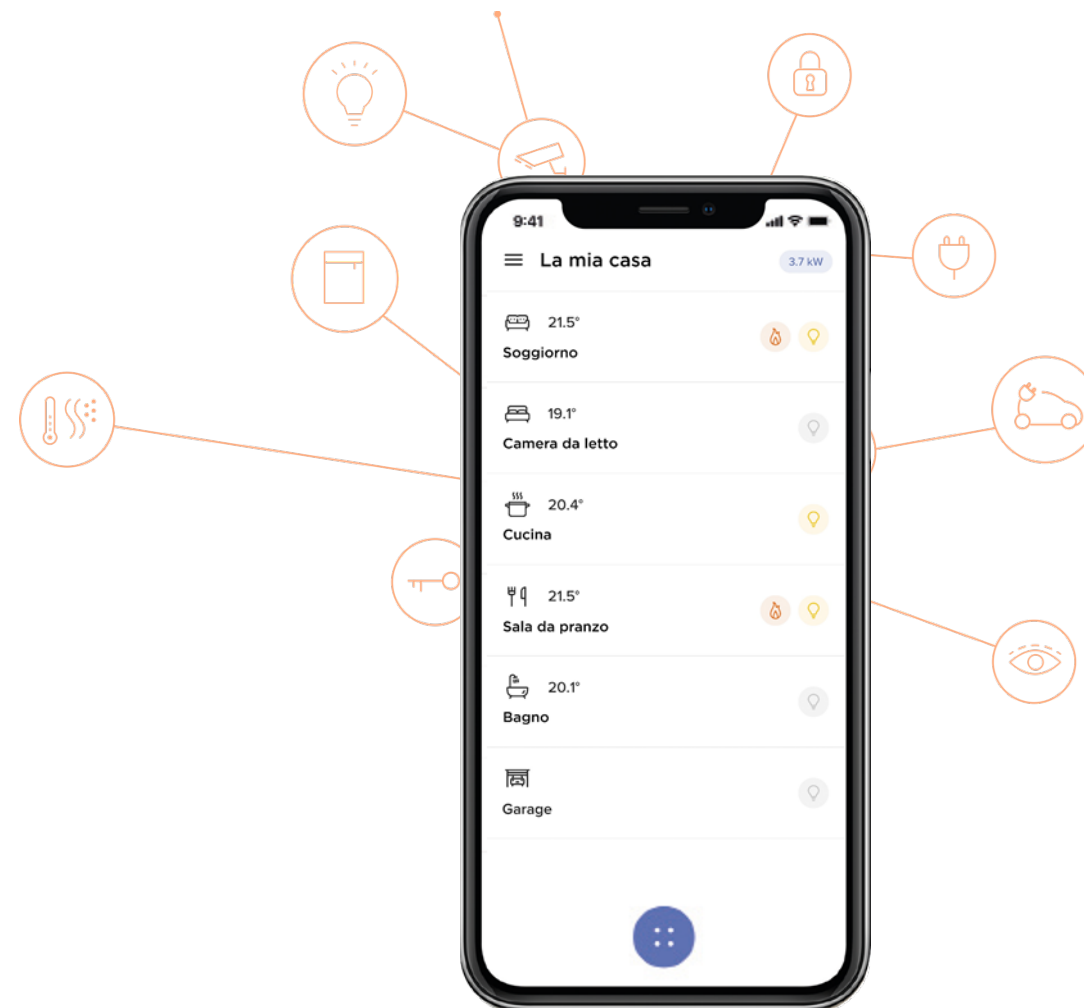
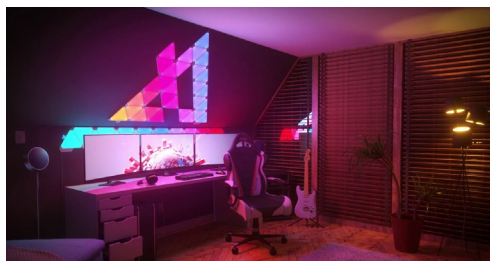
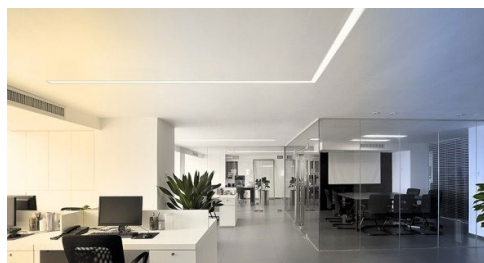
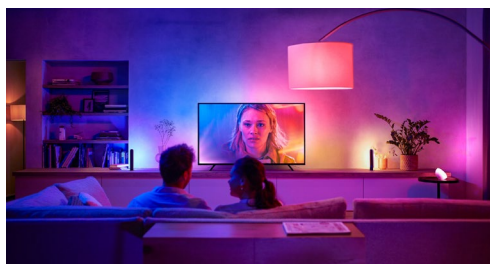
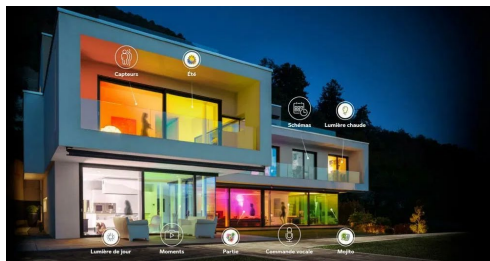



Bticino Conectado



E27



E14



GU10



B22



STRIP LED



LED PANELS



ZIGBEE DALI
CONVERTER



ZIGBEE LED DRIVER



DOWNLIGHTS



Bticino Conectado



K4500C



K4510C

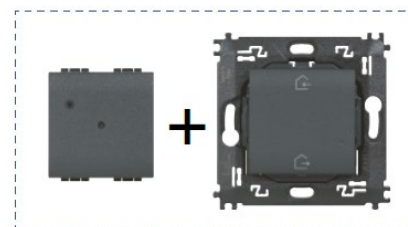

Artículo L/N/NT4500C

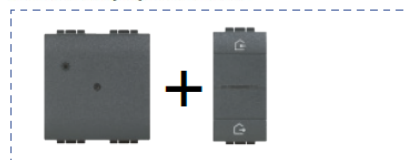

Artículo L/N/NT4510C

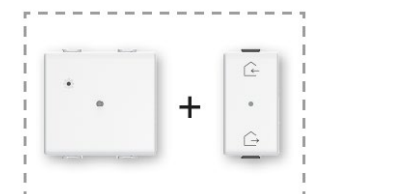

Art. AM4510C

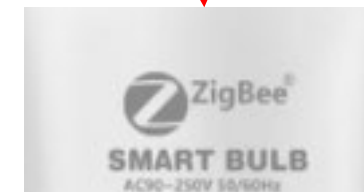
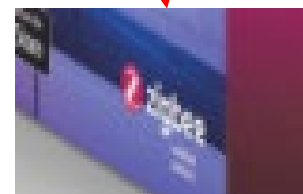

- El Gateway “with Netatmo” es compatible con luminarias certificadas Zigbee 3.0



ZIGBEE LOGO

- Éste logo debe estar presente en el empaque



Bticino Conectado

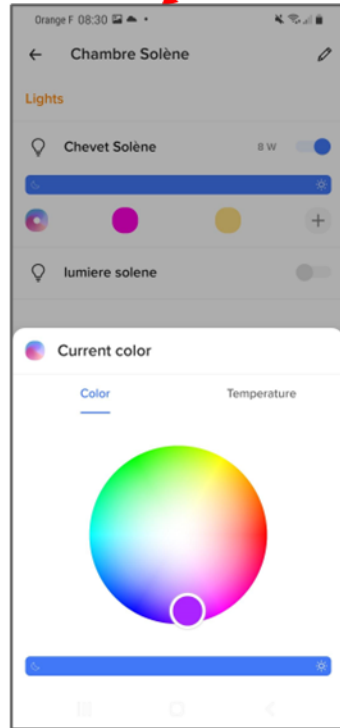
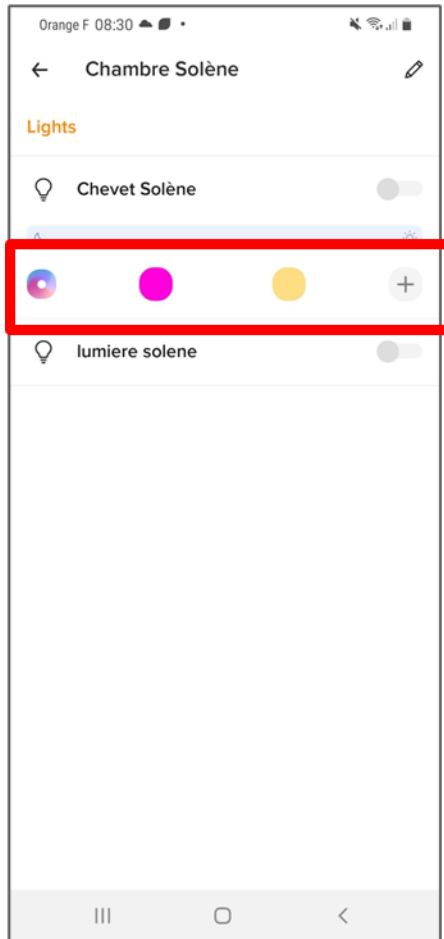

RGBW COLOR CONTROL

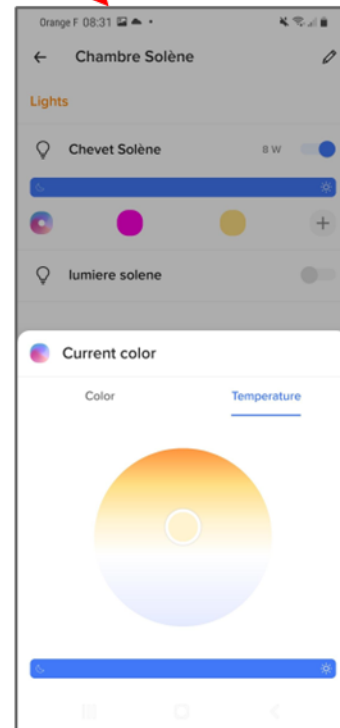

TW COLOR CONTROL

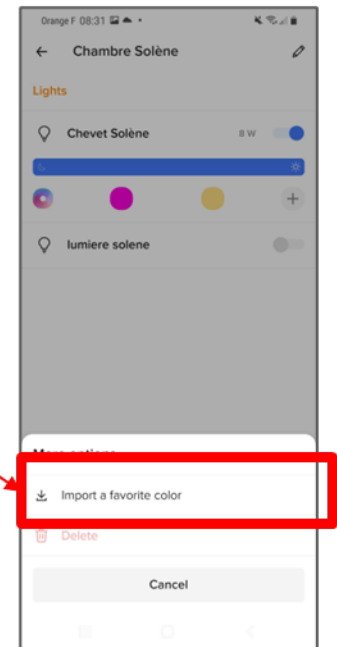
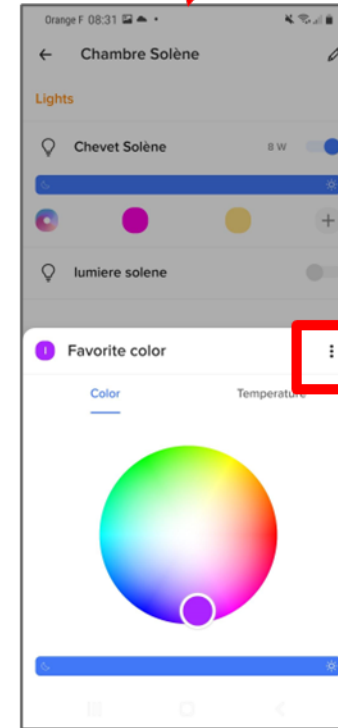

CHOOSE 3 FAVORITES COLORS

IMPORT FAVORITE COLOR FROM OTHER BULBS



Bticino Conectado



E27



E14



GU10



B22



STRIP LED



LED PANELS



ZIGBEE DALI
CONVERTER

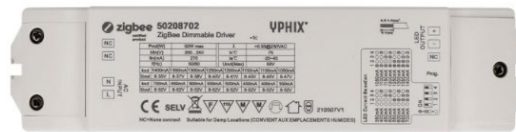

ZIGBEE LED DRIVER



DOWNLIGHTS



Art. K4003CW



Art. K4003CWI



N4003CW
NT4003CW
L4003CW



LN4003CWI



Art. AM4003CWI
Mando inalámbrico
aluminado



Consideraciones

Aspectos eléctrico

- Solo es necesario 1 Gateway por instalación
- Módulos para iluminación requiere neutro
- Enchufe conectado, hasta 16A

Aspecto comunicación

- Comunicación Wifi 2,4GHz
- Cada producto Zigbee es un repetidor
- Zigbee no satura Wifi y no depende del proveedor de Internet
- Distancia entre 2 dispositivos 10-20mts

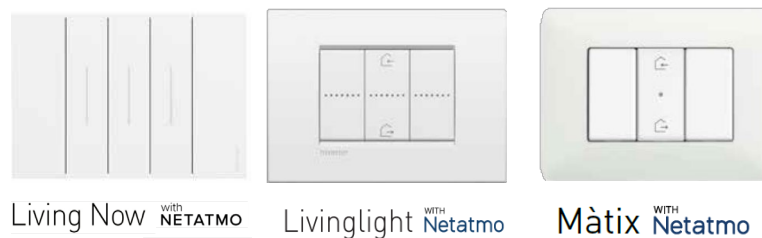

SERIES ELECTRICAS SMART PARA CONTROLAR PERSIANAS, ILUMINACIÓN & ENCHUFES FACILMENTE DESDE TU VOZ, SMARTPHONE, O PLACA



Home + Control

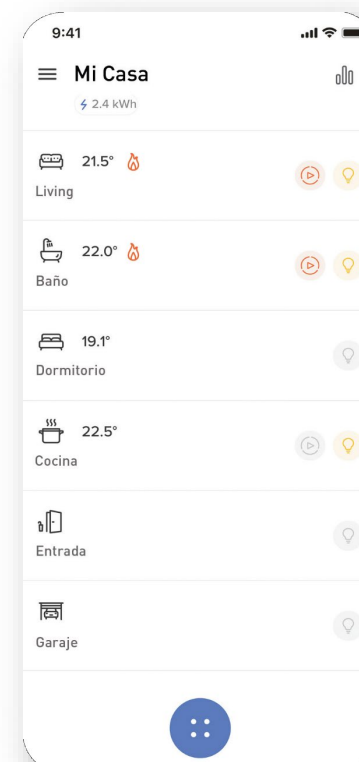

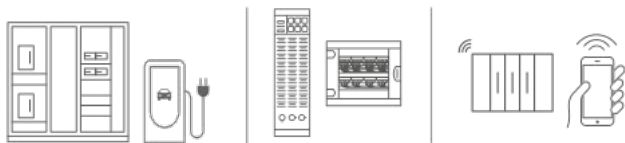

Citofonía Conectada

Relator: Oscar Godoy
Product Manager



Aportando valor a tu profesión

legrand | bticino
academy
PROGRAMAS DE CAPACITACIÓN

Citofonía Conectada



EASY KIT



CLASSE 100X



CLASSE 300EOS





Citofonía Conectada



CLASSE 300EOS



https://youtu.be/os80Wm_U_zc?si=vjoi52J3aE4vDFQJ





Citofonía Conectada



CLASSE 100X



Nuevo
Classe 100



Citofonía Conectada



EASY KIT

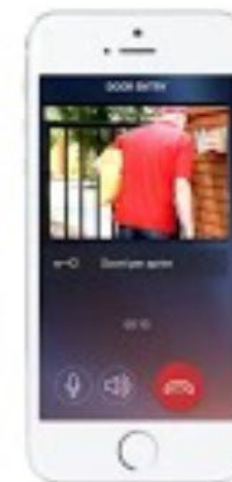
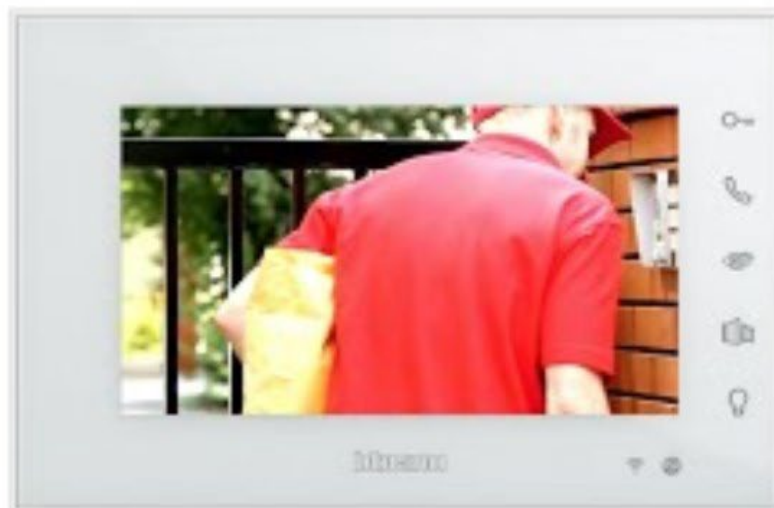

*Abre la puerta
a distancia y...*



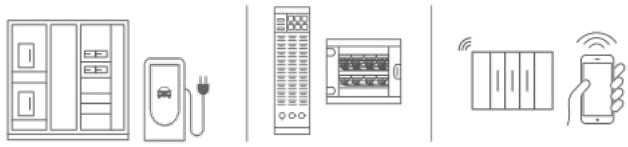

Netatmo Security

Relator: Oscar Godoy
Product Manager



Aportando valor a tu profesión

legrand | bticino
academy
PROGRAMAS DE CAPACITACIÓN



Netatmo Security

GAMA DE SEGURIDAD NETATMO
Proteja su hogar y evite robos con una solución de seguridad completa



Netatmo Security

NETATMO Cámara exterior Smart

Alertas instantáneas en su smartphone cuando un vehículo o una persona es vista en su propiedad



Elegir alertas por personas, autos o animales en su propiedad



Iluminación integrada para disuadir a no invitados o iluminar su camino



Zona-Alerta: Seleccionar áreas específicas de alertas



Almacenamiento gratuito de video, sin pagos mensuales

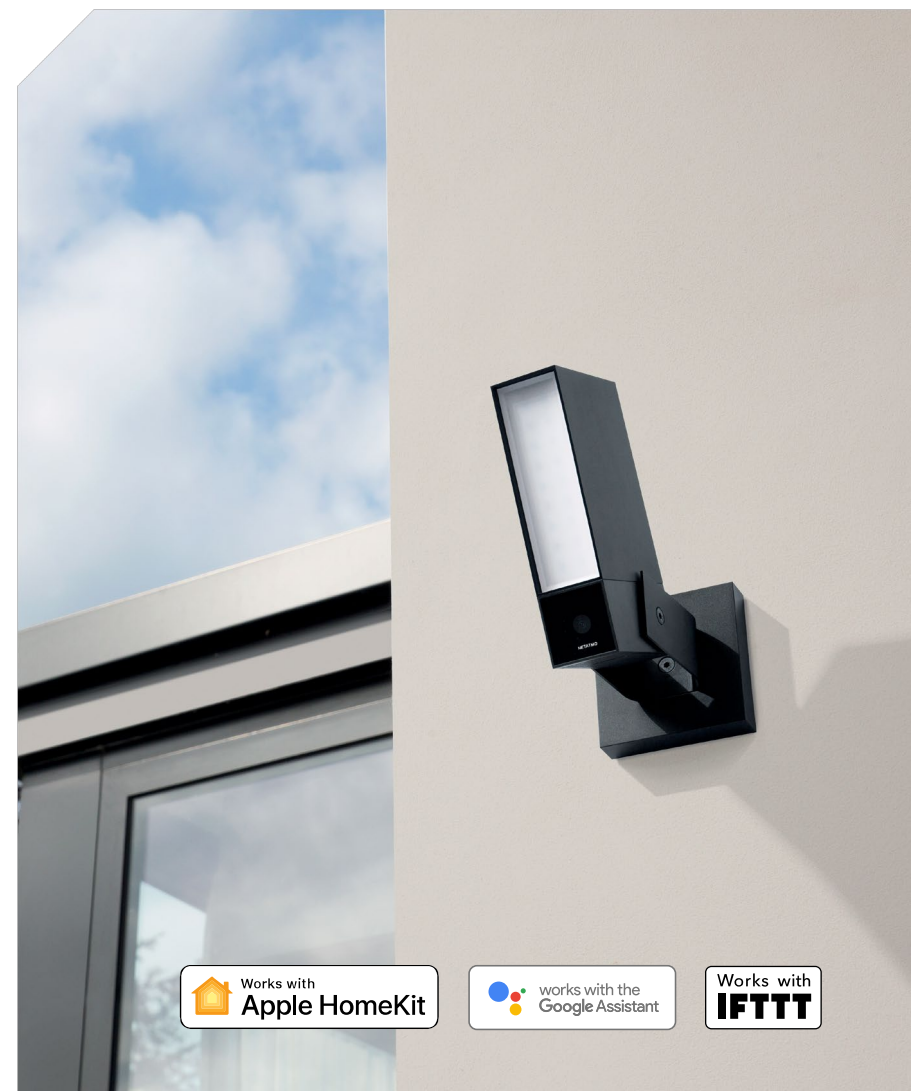

Netatmo Security



NETATMO

Cámara interior Smart

Alertas instantáneas en su teléfono si se ve a un intruso en su casa



Alerta de intruso en su teléfono



Privacidad: dejar a la familia fuera del registro



Notificación cuando se escucha alarmas



Almacenamiento de video gratuito, sin tarifa mensual



Netatmo Security



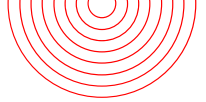

Netatmo Security



NETATMO welcome

Cámara de seguridad doméstica
con reconocimiento facial



NETATMO presence

Cámara de seguridad exterior que distingue
entre personas, vehículos y animales





Netatmo – Weather Station



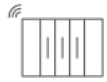

Resumen Beneficios

Relator: Oscar Godoy
Product Manager



Aportando valor a tu profesión

legrand | bticino
academy
PROGRAMAS DE CAPACITACIÓN



Beneficios al usuario

COMODIDAD

ESCENARIOS

Active y personalice los escenarios a través la aplicación (entrar, salir, día, noche).



NO TE PIERDAS UNA ENTREGA

Contesta el videoportero y abre la puerta en todas partes.



CONFORT

Cambia la temperatura del hogar en cualquier momento. Por ejemplo, si llega a casa antes de lo esperado, puede configurar la función Boost mientras viaja para encontrar la temperatura deseada en casa.



SENCILLEZ

COMANDO GENERAL

Apague todas las luces y baje todas las persianas cuando salga de la casa con un solo clic.



COMANDO INALÁMBRICO

Agregue o cambie de lugar los controles inalámbricos en cualquier momento según sus necesidades.



RESPUESTA REMOTA

Conteste y abra la puerta desde el sofá o lejos de casa.



SEGURIDAD

CONTROL DE CONSUMO DE ENERGÍA

Verifique el consumo de electricidad de su hogar desde su smartphone y reciba una notificación para evitar un apagón si se excede del límite de energía.



CONTROL DE LAS CARGAS DE PRIORIDAD PARA EVITAR UN APAGÓN

En una condición de sobrecarga, el sistema desconecta automáticamente la carga menos importante para evitar la intervención del medidor (apagón).



NOTIFICACIONES DE ALARMA

Reciba notificaciones en su teléfono inteligente para recibir alertas en caso de mal funcionamiento (apagón, falla de electrodomésticos).



CONTROL DESDE EL SMARTPHONE

Una sola aplicación HOME + CONTROL para gestionar luces, persianas, energía y termoregulación.

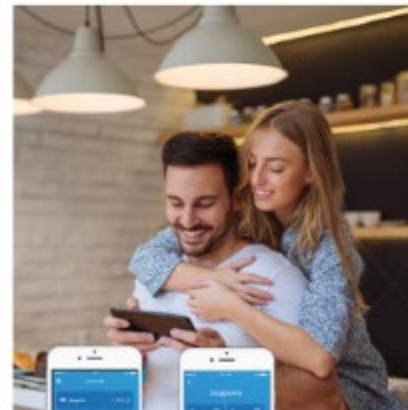

CONTROL POR VOZ

Controle su hogar a través de su asistente de voz favorito.



CONTROL DE VIDEO

Vea lo que sucede dentro y fuera de la casa, por ejemplo, verificando si los niños regresaron de la escuela.



SEGURIDAD

Verifique quién llama directamente desde su Smartphone, incluso desde el exterior.





¡Síguenos!



Oscar Godoy
legrandacademychile@legrand.cl
legrand.cl

